

Solutions for Life.™

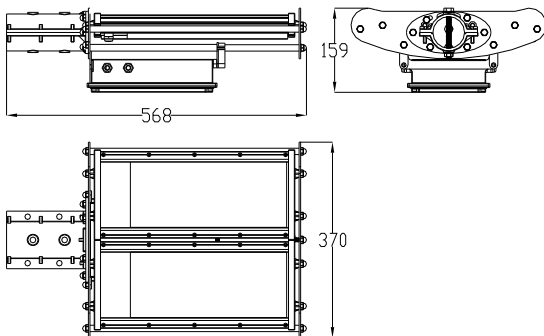

PRODUCT SPECIFICATION SHEET (AX-STWF0002)

90 LED STREET LIGHT



Product Key Features

- Lamp-house: 1W LED
- Input voltage: AC100-240V 50/60Hz
- Colour temperature: 2700K/5000K/8000K
- LED luminous efficiency: >70lm/w
- Beam angle: 130° x 60°
- Luminous flux: 6400lm
- Illumination: 20 lux/8M
- LED quantity: 90pcs
- CRI: Ra>75
- Operating temperature: -20°C ~ 40°C
- Installation tube diameter: Ø60mm (MAX)



Overview

Axent's range of LED street lights are made from die-cast aluminium and low-iron crystal tempered glass to allow for heat dissipation and light transmittance.

Our street lights are small in size and light weight which assists in lower wind resistance and are suitable for most existing or light weight street poles in existence in most capital cities.

LED street lights have high luminance efficiency, no pollution and run at a low temperature. This ensures a long life street light which maintains a consistent colour throughout its operational life.

Spectrum

